

Dual-mode Bluetooth Serial Port Transparent Transmission Module

JDY-33 Bluetooth Module Manual

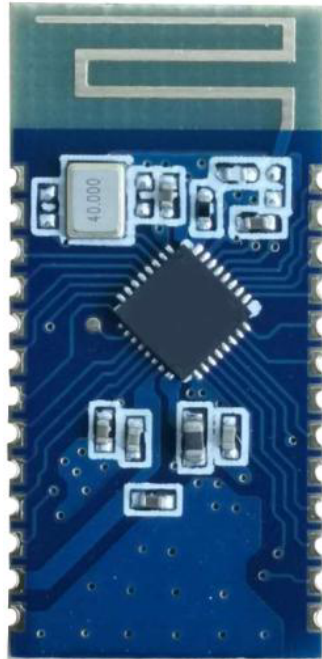

JDY-33 Bluetooth SPP Serial Port Transparent Transmission Module

Version

Version	Date	Description
V1.2	2019-05-15	Release version
V1.4	2019-06-01	Added AT+STTS instruction
V1.6	2019-06-15	This version has been validated by a large number of customers and been largely produced. It is very stable. It is recommended to use V1.6 version.

I. Product Introduction and Application

JDY-33 Bluetooth is designed based on Bluetooth 3.0 SPP+BLE, which can support data transmission of Windows, Linux, Android, and IOS, with 2.4 GHZ working frequency band, GFSK modulation mode, 6 db maximum transmission power, 30 meters of maximum transmission distance. It supports users to modify device name, baud rate and other instructions through AT commands, which is convenient, fast and flexible.

JDY-33 has obvious advantages. It supports Bluetooth communication between SPP and computer, APP or Wechat applet, and communication between master and slave of JDY-18.

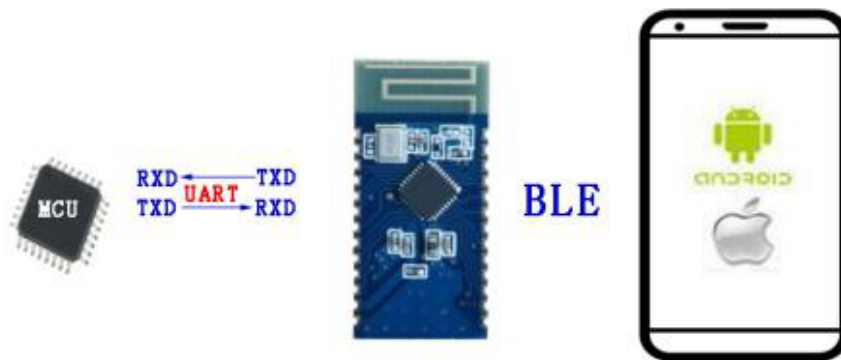

MODULE SUPPORTS BLUETOOTH COMMUNICATION WITH MOBILE APP, WECHAT APPLET OR COMPUTER.

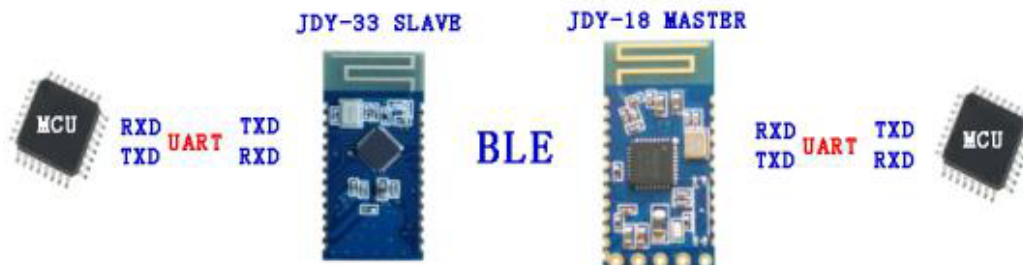

MODULE MASTER-SLAVE COMMUNICATION

JDY-33 Bluetooth SPP Serial Port Transparent Transmission Module

II. Product Application

JDY-33 is a classic Bluetooth+BLE dual-mode Bluetooth, which can communicate with Bluetooth-enabled computers (desktop, notebook), mobile phones (Android), and IOS. It can be applied to

- ◆ Bluetooth POS
- ◆ Thermal printer
- ◆ Smart home control
- ◆ Automobile ODB detection equipment
- ◆ Application of Bluetooth transparent transmission products
- ◆ Shared chargers, weight scale

III. Detailed Module Parameters

Model	JDY-33
Working frequency band	2.4GHZ
Communication interface	UART
Working voltage	1.8-3.6V(3.3V recommended)
Working temperature	-40℃ - 80℃
Antenna	Built-in PCB antenna
Transmission distance	30 meters
Master-slave support	Slave machine
Module size	26.7 * 13 *1.7 mm(Length, width and height)
Bluetooth version	Bluetooth 3.0 SPP + BLE4.2
SMT Welding Temperature	<260℃
Working Current	6.5mA
Deep sleep current	<10uA
Transmitting power	6db(Maximum)
Receiving sensitivity	-96dbm
SPP maximum throughput	16K bytes/s(android、 windows) When connected with Android and computer Bluetooth, the communication speed can reach 16K bytes/s, and there is no loss of packets (supporting serial port to receive and send data

JDY-33 Bluetooth SPP Serial Port Transparent Transmission Module

	continuously).
BLE	4K bytes/s(android、IOS) The communication speed is 4K bytes/s when BLE connects with IOS or Android (supporting 38400 baud rate to continuously send and receive data. If the baud rate is higher than 38400, the data cannot be sent continuously, and delay shall be added in the middle)

IV. Pin function and Application

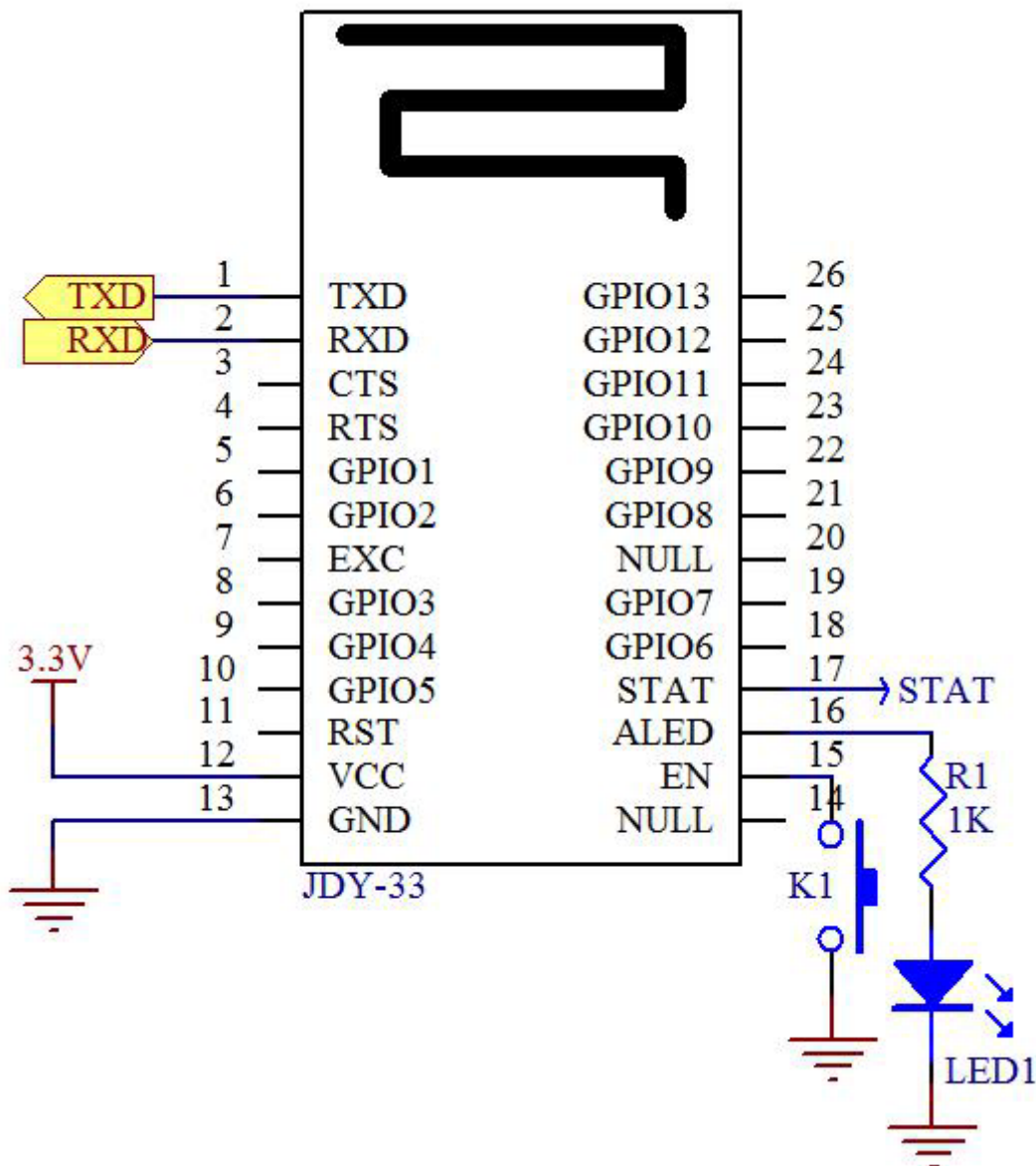

JDY-33 applications only need to connect VCC, GND, RXD and TXD pins. The connection state requires a disconnect, send `AT+DISC\r\n`. Send `AT+SLEEP\r\n` for deep SLEEP in unconnected state. Deep sleep can be awakened by the falling edge of EN pin, or by sending data through serial port. It is generally recommended to use serial port to send `AT+VERSION\r\n` instruction to wake up.

V. Pin function description

Pin No.	Pin function	Pin function description
1	TXD	Serial port output in (TTL Level)
2	RXD	Serial port input pin (TTL level)
3	CTS	Serial port flow control CTS pin
4	RTS	Serial port flow control RTS pin
5	GPIO1	Default no function (Input and output of IO control can be customized according to customer needs)
6	GPIO2	Default no function (Input and output of IO control can be customized according to customer needs)
7	EXC	Default no function (Input and output of IO control can be customized according to customer needs)
8	GPIO3	Default no function (Input and output of IO control can be customized according to customer needs)
9	GPIO4	Default no function (Input and output of IO control can be customized according to customer needs)
10	GPIO5	Default no function (Input and output of IO control can be customized according to customer needs)
11	RST	Reset (Low level effective)
12	VCC	Power supply (1.8-3.6V)
13	GND	Ground
14	NULL	
15	EN	Input pin for sleep awakening (falling edge valid)
16	ALED	Broadcast status pin (Flash when not connected, output high level after connected)
17	STAT	Connection status pin (Low level when not connected, output high level after connected)
18	GPIO6	Default no function (Input and output of IO control can be customized according to customer needs)
19	GPIO7	Default no function (Input and output of IO control can be customized according to customer needs)
20	NULL	
21	GPIO8	Default no function (Input and output of IO control can be customized according to customer needs)
22	GPIO9	Default no function (Input and output of IO control can be customized according to customer needs)
23	GPIO10	Default no function (Input and output of IO control can be customized according to customer needs)
24	GPIO11	Default no function (Input and output of IO control can be customized according to customer needs)
25	GPIO12	Default no function (Input and output of IO control can be customized according to customer needs)

JDY-33 Bluetooth SPP Serial Port Transparent Transmission Module

		customized according to customer needs)
26	GPIO13	Default no function (Input and output of IO control can be customized according to customer needs)

VI. PCB Package Size

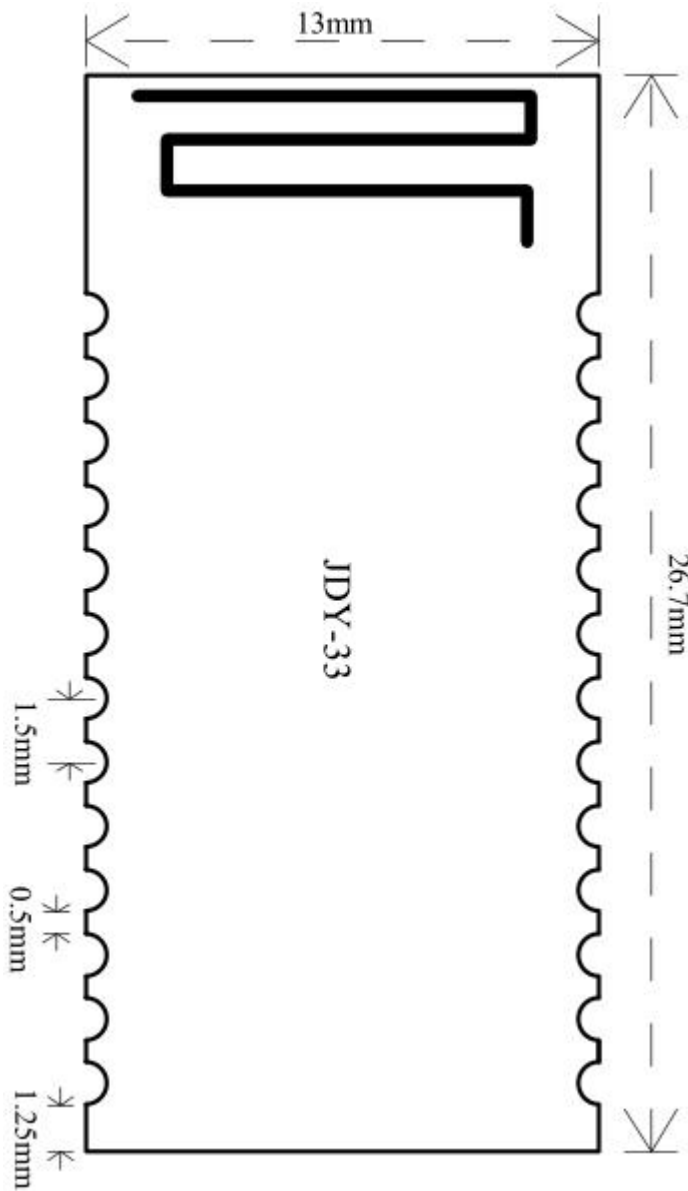

PCB package is fully compatible with JDY-30, JDY-31, JDY-09, JDY-32

VII. Serial Port AT Instruction Set

JDY-33 module serial port must add \r\n when sending AT instruction

No.	Instruction	Function	Default
1	AT	Test	
2	AT+VERSION	Version number	JDY-33-V1.1
3	AT+STAT	Query connection status	00
4	AT+SLEEP	Sleep	-
5	AT+BAUD	Baud rate setting and query	9600
6	AT+NAME	Broadcast name setting and query	JDY-33-SPP
7	AT+NAMB	BLE broadcast name setting and query	JDY-33-BLE
8	AT+PIN	Connection password setting and query	1234
9	AT+LADDR	MAC address of module query	
10	AT+RESET	Soft reset	-
11	AT+DEFAULT	Restore factory settings	-
12	AT+DISC	Disconnect (valid in connection state)	-
13	AT+TYPE	Setting and query paired password switch	0
14	AT+ENLOG	Serial port state output enable	1
15	AT+UUIDLEN	Setting and query UUID length	0
16	AT+SVRUUID	BLE service UUID setting and query	FFE0
17	AT+CHRUUID	BLE feature UUID setting and query	FFE1
18	AT+CRXUUID	BLE feature UUID setting and query	FFE2

JDY-33 Bluetooth SPP Serial Port Transparent Transmission Module

		query	
19	AT+UARTMOD E	Serial port parity bit setting and query	No check bit
20	AT+STTS	STAT pin function setting and query	0

Application of AT instruction serial port tool

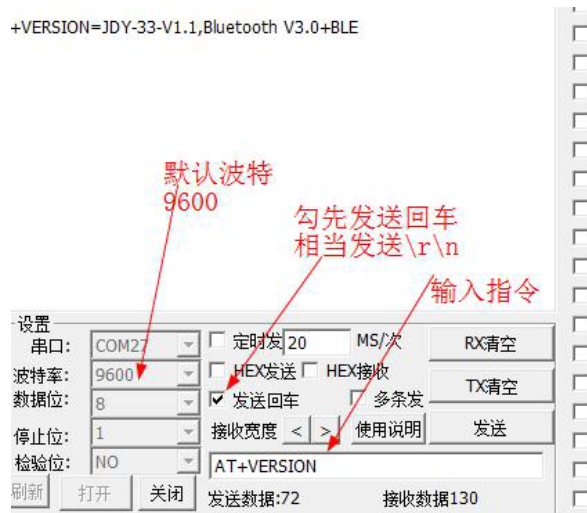

Method of sending disconnection instructions in connection state

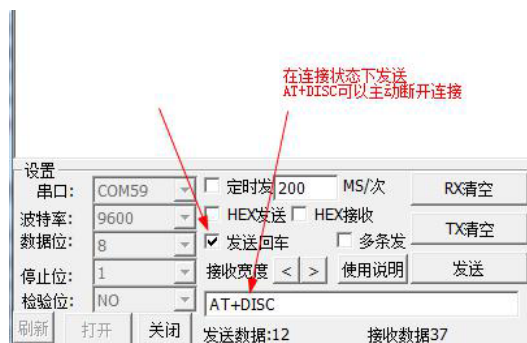

JDY-33 Bluetooth SPP Serial Port Transparent Transmission Module

1、Test instruction

Instruction	Response	Parameter
AT	+OK	None

2、Query version number

Instruction	Response	Parameter
AT+VERSION	+VERSION=JDY-33-V1.1,Bluetooth V3.0+BLE	None

3、Query connection status

Instruction	Response	Parameter
AT+STAT	+STAT=<Param>	Param(01-02) 01: Indicates BLE connected 02: Indicates SPP connected

Connection status can be queried by this instruction in connection state.

4、Setting deep sleep

Instruction	Response	Parameter
AT+SLEEP	+OK	None

No broadcasting after deep sleep, the current is about 3uA.

JDY-33 Bluetooth SPP Serial Port Transparent Transmission Module

5、Baud Rate Setting/Query

Instruction	Response	Parameter
AT+BAUD<Param>	+OK	Param:(4 to 9)
AT+BAUD	+BAUD=<Param>	2: 2400 3: 4800 4: 9600 5: 19200 6: 38400 7: 57600 8: 115200 9: 128000

JDY-33 supports 128000 baud rate continuous data transmission without losing packets, and the transmission speed can reach 16K bytes per second.

6、SPP Broadcast Name Setting/Query

Instruction	Response	Parameter
AT+NAME<Param>	+OK	Param: SPP Broadcast Name
AT+NAME	+NAME=<Param>	Maximum: 18 bytes Default broadcast name: JDY-33-SPP

7、BLE Broadcast Name Setting/Query

Instruction	Response	Parameter
AT+NAMB<Param>	+OK	Param: BLE Broadcast Name
	+NAME=<Param>	Maximum: 18 bytes Default broadcast name: JDY-33-BLE

JDY-33 Bluetooth SPP Serial Port Transparent Transmission Module

8、SPP Bluetooth Paired Password

Instruction	Response	Parameter
AT+PIN<Param>	+OK	Param: 4 bit password
AT+PIN	+PIN=<Param>	Defaulted PIN: 1234

9、Bluetooth MAC address

Instruction	Response	Parameter
AT+LADDR<Param>	+OK	Param:MAC address is a
AT+LADDR	+LADDR=<Param>	hexadecimal string

Query MAC address: AT+LADDR\r\n

Setting MAC address: AT+LADDR112233445566\r\n

Setting MAC address: AT+LADDR11:22:33:44:55:66\r\n

10、Reset

Instruction	Response	Parameter
AT+RESET	+OK	None

11、Restore factory configuration

Instruction	Response	Parameter
AT+DEFAULT	+OK	None

12、Disconnect

Instruction	Response	Parameter
AT+DISC	+OK	None

Effective after connection

JDY-33 Bluetooth SPP Serial Port Transparent Transmission Module

13、Setting/Query SPP Password Connection

Instruction	Response	Parameter
AT+TYPE<Param>	+OK	Param(01-02)
AT+TYPE	+TYPE=<Param>	1: SPP connection with password 0: SPP connection with no password Default: 0

14、Serial port state output enable setting/query

Instruction	Response	Parameter
AT+ENLOG<Param>	+OK	Param: 1 or 0
AT+ENLOG	+ENLOG=<Param>	1: Open serial port status output 0: Close serial port status output Default: 1

15、UUID Length Setting/Query

Instruction	Response	Parameter
AT+UUIDLEN<Param>	+OK	Param: 1 or 0
AT+UUIDLEN	+UUIDLEN=<Param>	1: UUID length 128 0: UUID length 16 Default: 0

16、BLE Service UUID Setting/Query

Instruction	Response	Parameter
AT+SVRUUID<Param>	+OK	Param: UUID string
AT+SVRUUID	+SVRUUID=<Param>	Default: FFE0

JDY-33 Bluetooth SPP Serial Port Transparent Transmission Module

17、BLE feature UUID Setting/Query

Instruction	Response	Parameter
AT+CHRUUID<Param>	+OK	Param: UUID string
AT+CHRUUID	+CHUUUID=<Param>	Default: FFE1

18、BLE feature UUID Setting/Query

Instruction	Response	Parameter
AT+CRXUUID<Param>	+OK	Param: UUID string
AT+CRXUUID	+CRXUUID=<Param>	Default: FFE2

19、Serial port parity bit setting and query

Instruction	Response	Parameter
AT+UARTMODE<Param1>,<Param2>	+OK	Param1: Fixed to 0 Param2: 0 to 2 0: No check bit 1: Odd 2: Even
AT+UARTMODE	+UARTMODE=<Param1>,<Param2>	Default: 0

20、STAT pin function setting and query

Instruction	Response	Parameter
AT+STTS<Param>	+OK	Param: 0 to 1 0: STAT pins are low level when not
AT+STTS	+STTS=<Param>	connected, high level after connection, low level after disconnection 1: STAT pins are low level when not connected, high level after connection, and output low level after receiving data. If no data is received, high level is output after delay of 1.5s, and low level is output after disconnect Default: 0

VIII. Master-slave communication between JDY-18 and JDY-33

```
+ROLE=1
OK
OK
+DEV:1=A05544332211,-28,JDY-33-BLE
+DEV:2=F167800C9A64,-56,JDY-64A-BLE
+STOP:SCAN
OK
+CONNECTED>>0xA05544332211
```

JDY-18 is configured as a master: AT+ROLE1

JDY-18 search slave: AT+INQ

JDY-18 connection search gets slave machine: AT+CONNA05544332211

Output slave MAC address after successful connection: +CONNECTED>>0xA05544332211

FCC statement

This device complies with Part 15 of the FCC rules. Operation is subject to the following two conditions: 1) this device may not cause harmful interference, and 2) this device must accept any interference received, including interference that may cause undesired operation.

Note: This equipment has been tested and found to comply with the limits for a Class B digital device, pursuant to part 15 of the FCC Rules. These limits are designed to provide reasonable protection against harmful interference in a residential installation. This equipment generates uses and can radiate radio frequency energy and, if not installed and used in accordance with the instructions, may cause harmful interference to radio communications. However, there is no guarantee that interference will not occur in particular installation. If this equipment does cause harmful interference to radio or television reception, which can be determined by turning the equipment off and on, the user is encouraged to try to correct the interference by one or more of the following measures:

- Reorient or relocate the receiving antenna.
- Increase the separation between the equipment and receiver.
- Connect the equipment into an outlet on a circuit different from that to which the receiver is connected.
- Consult the dealer or an experienced radio/TV technician for help.

Changes or modifications not expressly approved by the party responsible for compliance could void the user's authority to operate the equipment.

FCC Radiation Exposure Statement

This device complies with FCC RF radiation exposure limits set forth for an uncontrolled environment. This transmitter must not be co-located or operating in conjunction with any other antenna or transmitter.

Integration instructions for host product manufacturers according to KDB 996369 D03 OEM Manual v01

2.2 List of applicable FCC rules

FCC Part 15.247.

2.3 Specific operational use conditions

This device is intended only for OEM integrators under the following conditions:

1) The transmitter module may not be co-located with any other transmitter or antenna.

As long as the condition above is met, further transmitter test will not be required. However, the OEM integrator is still responsible for testing their end-product for any additional compliance requirements required with this module installed.

IMPORTANT NOTE: In the event that these conditions can not be met (for example certain laptop configurations or co-location with another transmitter), then the FCC authorization is no longer considered valid and the FCC ID can not be used on the final product. In these circumstances, the OEM integrator will be responsible for re-evaluating the end product (including the transmitter) and obtaining a separate FCC authorization. The OEM integrator has to be aware not to provide information to the end user regarding how to install or remove this RF module in the user's manual of the end product which integrates this module. The end user manual shall include all required regulatory information/warning as show in this manual.

2.4 Limited module procedures

Additional testing and certification is necessary when specific host originally granted with this module.

2.5 Trace antenna designs

The module may be operated only with the PCB antenna with which it is authorized.

2.6 RF exposure considerations

Co-located issue shall be met as mentioned in "Specific operational use conditions" .

Product manufacturer shall provide below text in end-product manual

"Radiation Exposure Statement:

The product comply with the US portable RF exposure limit set forth for an uncontrolled environment and are safe for intended operation as described in this manual. The further RF exposure reduction can be achieved if the product can be kept as far as possible from the user body or set the device to lower output power if such function is available."

2.7 Antennas

Model name	Antenna type	Antenna gain
JDY33	PCB	-2dBi

2.8 Label and compliance information

Product manufacturers need to provide a physical or e-label stating

"Contains FCC ID: 2AXM8-JDY-33" with finished product

2.9 Information on test modes and additional testing requirements

Test tool: RF Test_V1.8.exe shall be used to set the module to transmit continuously

2.10 Additional testing, Part 15 Subpart B disclaimer

The module is only FCC authorized for the specific rule parts listed on the grant, and that the host product manufacturer is responsible for compliance to any other FCC rules that apply to the host not covered by the modular transmitter grant of certification. The final host product still requires Part 15 Subpart B compliance testing with the modular transmitter installed.